

Loft - Ścianka stała

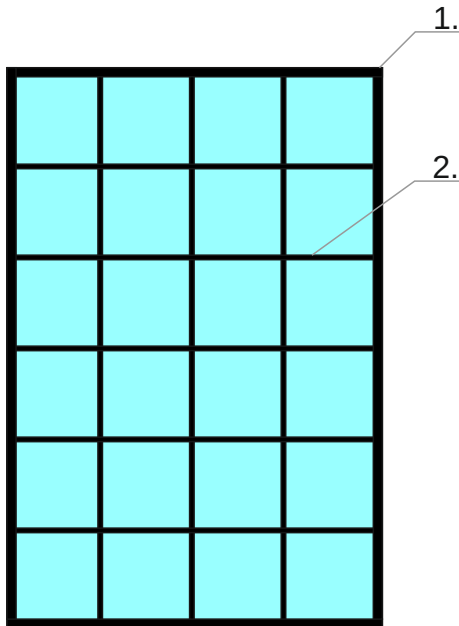

Elementy składowe

1. Profil montażowy

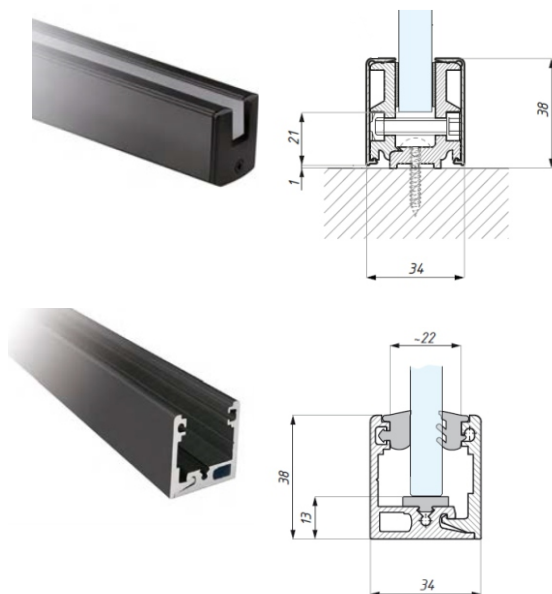

2. Szpros

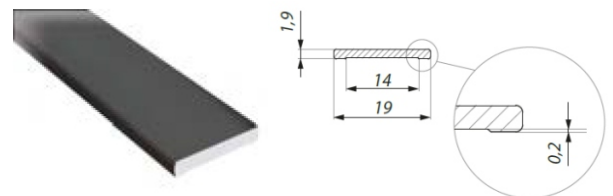

Dane do faktury:

P. W. Vitrobud
Krzysztof i Maria Matysek Sp. jawna
46-045 Turawa, ul. Sosnowa II
NIP: 9910313427
BPS O/Opole: 49 1930 1028 2240 0242 7085 0001

www.vitrobud.pl

Adres firmy:

1/6
45-315 Opole, ul. Głogowska 23
tel. (077) 441 64 84
tel. (077) 441 64 88
fax (077) 441 64 69
e-mail: matysek@vitrobud.com.pl

Loft - Drzwi przymykowe

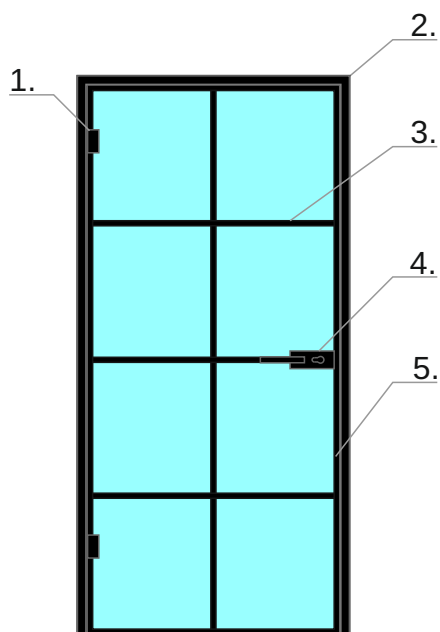

3. Szpros

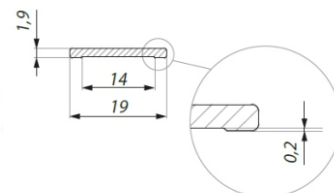

4. Zamek

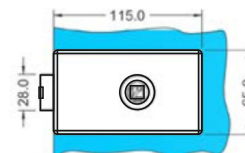
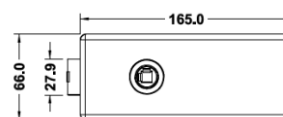
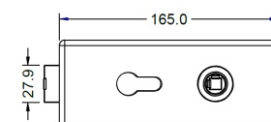

Elementy składowe

1. Zawias Simpli

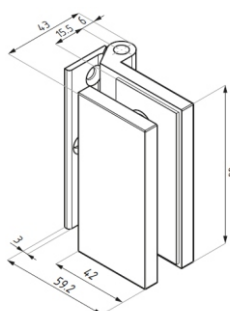

2. Profil Ościeżnicowy H

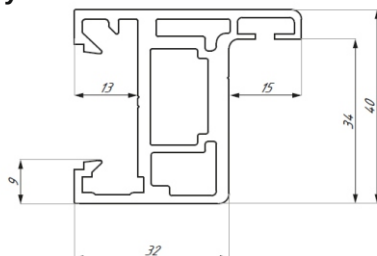

5. Profil nakładany

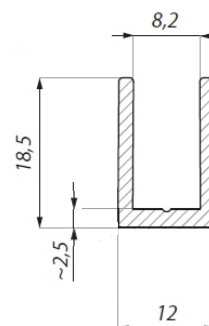

Dane do faktury:

P. W. Vitrobud
Krzysztof i Maria Matysek Sp. jawna
46-045 Turawa, ul. Sosnowa II
NIP: 9910313427
BPS O/Opole: 49 1930 1028 2240 0242 7085 0001

www.vitrobud.pl

Adres firmy:

2/6
45-315 Opole, ul. Głogowska 23
tel. (077) 441 64 84
tel. (077) 441 64 88
fax (077) 441 64 69
e-mail: matysek@vitrobud.com.pl

Loft - Drzwi przymykowe

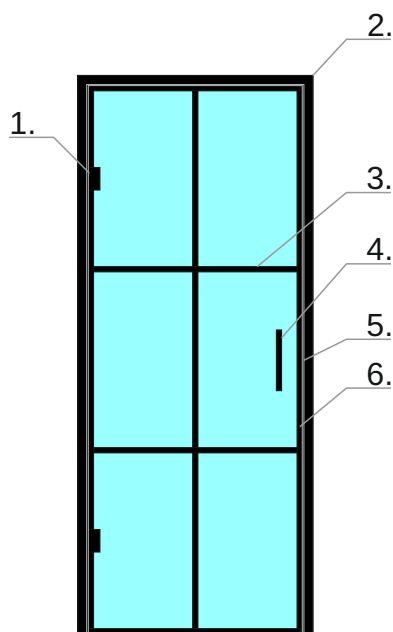

3. Szpros

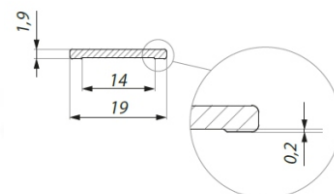

4. Pochwyt

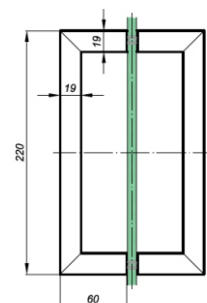

Elementy składowe

1. Zawias Simpli

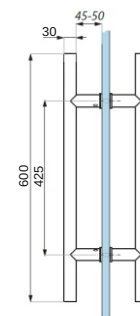
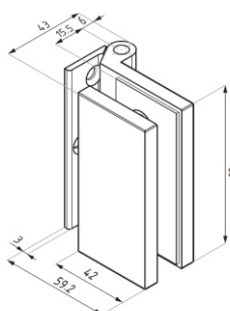

2. Profil Ościeżnicowy H

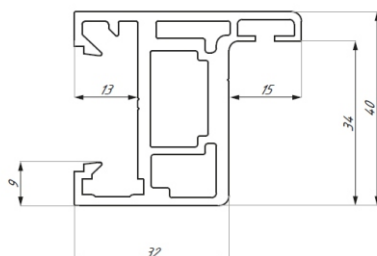

5. Profil nakładany

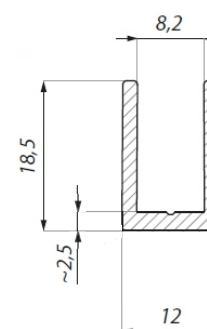

6. Zamek Rolkowy



Dane do faktury:

P. W. Vitrobud
Krzysztof i Maria Matysek Sp. jawna
46-045 Turawa, ul. Sosnowa II
NIP: 9910313427
BPS O/Opole: 49 1930 1028 2240 0242 7085 0001

www.vitrobud.pl

Adres firmy:

3/6
45-315 Opole, ul. Głogowska 23
tel. (077) 441 64 84
tel. (077) 441 64 88
fax (077) 441 64 69
e-mail: matysek@vitrobud.com.pl

Loft - Drzwi wahadłowe

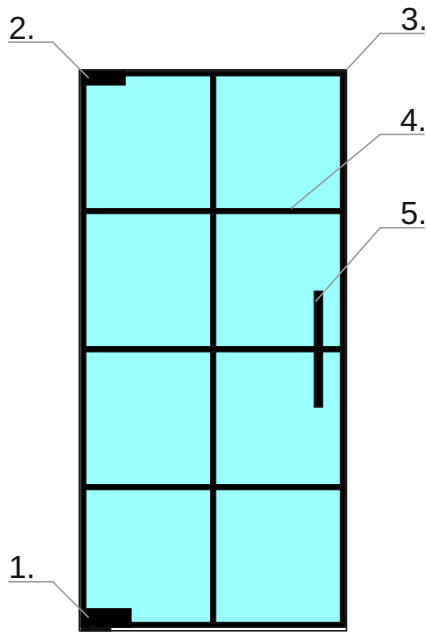

Elementy składowe

3. Profil nakładany

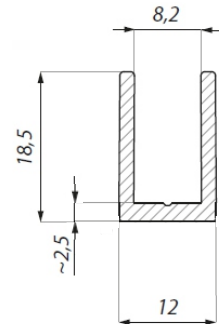

4. Szpros

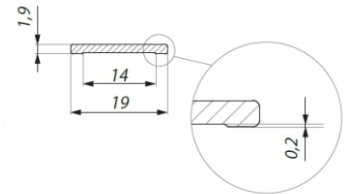

1. Zawias Felini

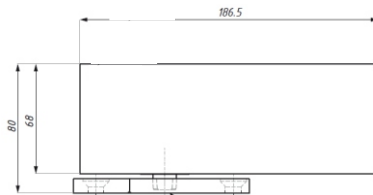

5. Pochwyty

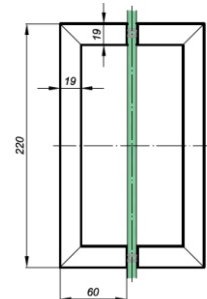

2. Zawias górny

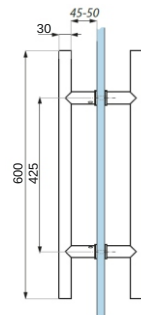
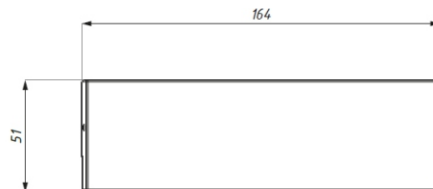

Dane do faktury:

P. W. Vitrobud
Krzysztof i Maria Matysek Sp. jawna
46-045 Turawa, ul. Sosnowa II
NIP: 9910313427
BPS O/Opole: 49 1930 1028 2240 0242 7085 0001

www.vitrobud.pl

Adres firmy:

4/6
45-315 Opole, ul. Głogowska 23
tel. (077) 441 64 84
tel. (077) 441 64 88
fax (077) 441 64 69
e-mail: matysek@vitrobud.com.pl

Loft - Drzwi przymykowe i ścianka stała

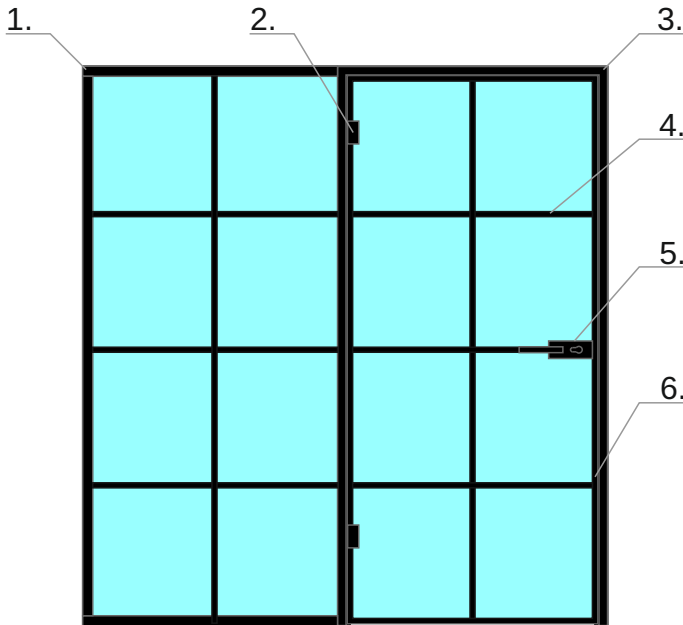

Elementy składowe

1. Profil montażowy

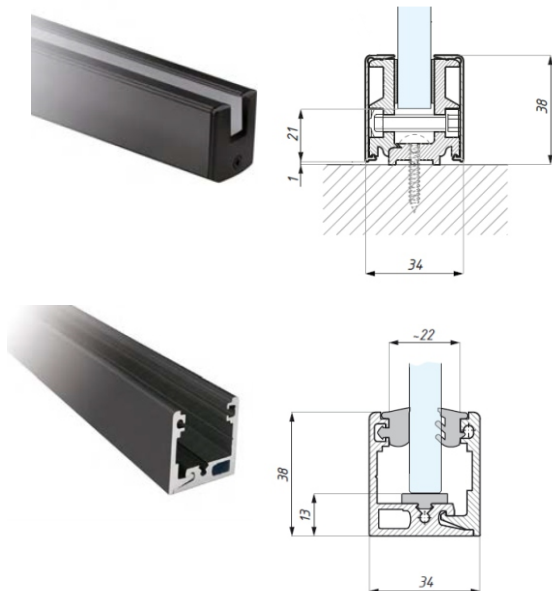

3. Profil Ościeżnicowy H

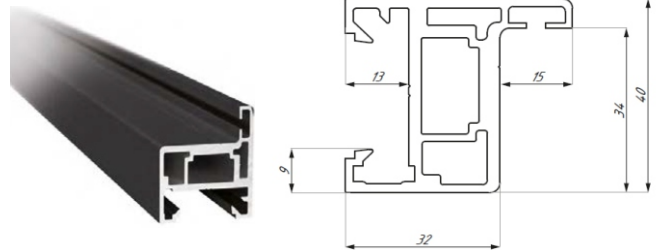

4. Szpros

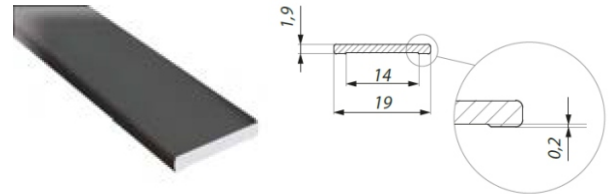

5. Zamek

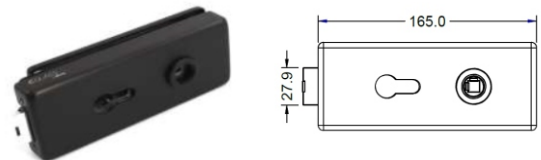

6. Profil nakładany

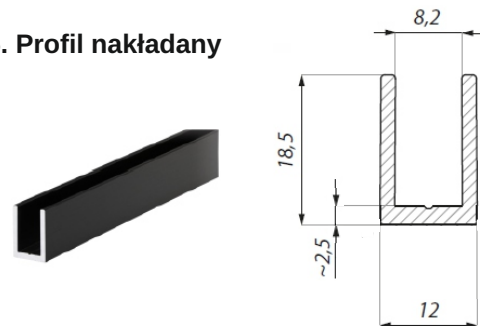

Dane do faktury:

P. W. Vitrobud
Krzysztof i Maria Matysek Sp. jawna
46-045 Turawa, ul. Sosnowa II
NIP: 9910313427
BPS O/Opole: 49 1930 1028 2240 0242 7085 0001

www.vitrobud.pl

Adres firmy:

5/6
45-315 Opole, ul. Głogowska 23
tel. (077) 441 64 84
tel. (077) 441 64 88
fax (077) 441 64 69
e-mail: matysek@vitrobud.com.pl

Loft - Drzwi przesuwne

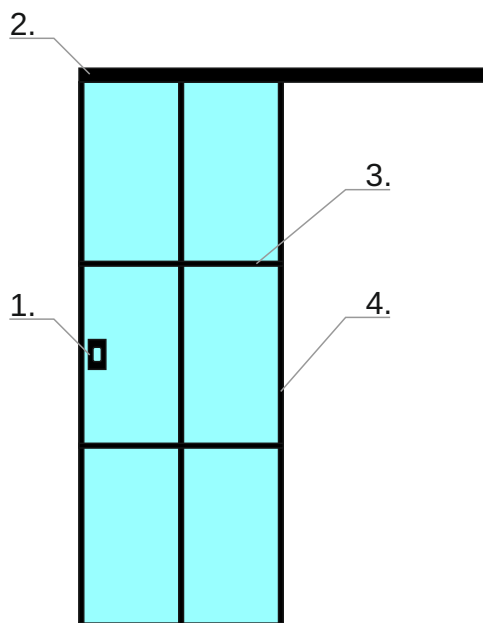

Elementy składowe

1. Pochwyt PPP1

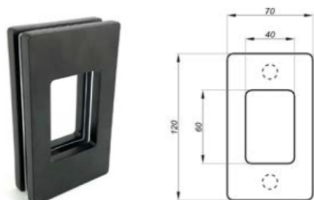

3. Szpros

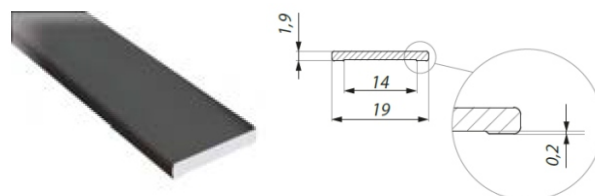

2. System przesuwny



4. Profil nakładany

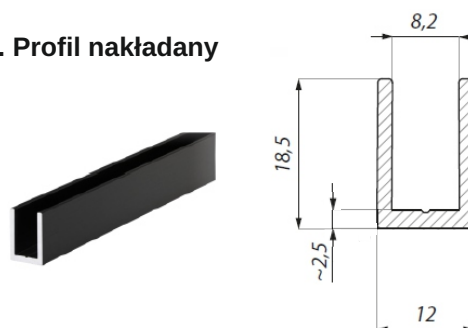

Dane do faktury:

P. W. Vitrobud
Krzysztof i Maria Matysek Sp. jawna
46-045 Turawa, ul. Sosnowa II
NIP: 9910313427
BPS O/Opole: 49 1930 1028 2240 0242 7085 0001

www.vitrobud.pl

Adres firmy:

6/6
45-315 Opole, ul. Głogowska 23
tel. (077) 441 64 84
tel. (077) 441 64 88
fax (077) 441 64 69
e-mail: matysek@vitrobud.com.pl